

48W IP67

I ² t				220Vac 25 10%I _{pk} -10%I _{pk} = 1.72 μs
				33.6~ 48W

				100%
				0% - 100% 20MHz 0.1μF 47μF
				100%
				100%
				220Vac
				/

25 C

				100% 25°
				220 Vac 25 80% (MIL-HDBK-217F)
				220 Vac 80% 70

				5
(L x W x H)	5.28 x 1.57 x 0.98			6.1 x 1.57 x 0.98
(L x W x H)	134 x 40.0 x 25.0			155 x 40.0 x 25.0

25 C

EMI	
EMS	

EMS	

1 EMI

() EMI

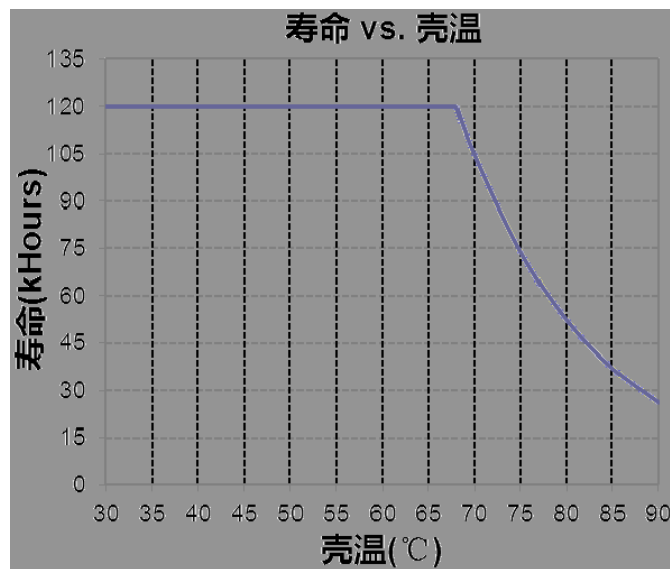
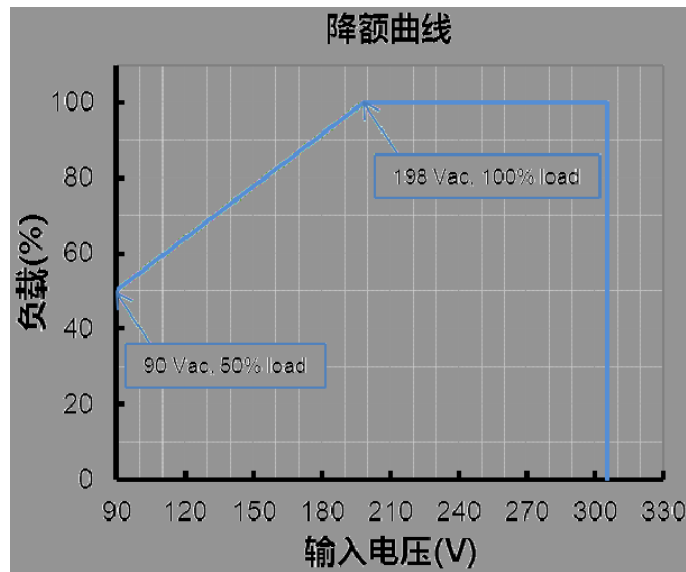

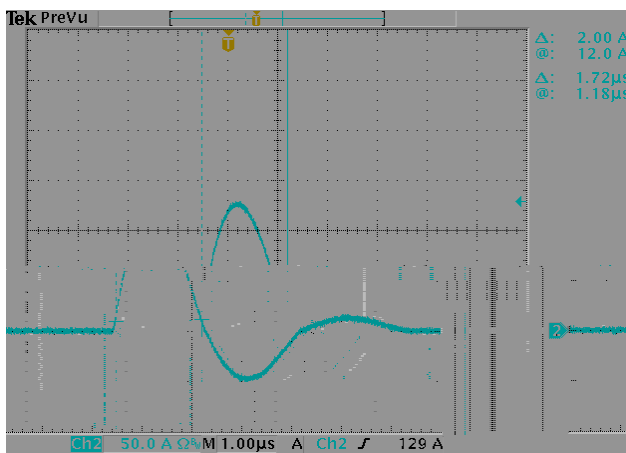

EBV-048S024SVF
效率 vs. 输出电流

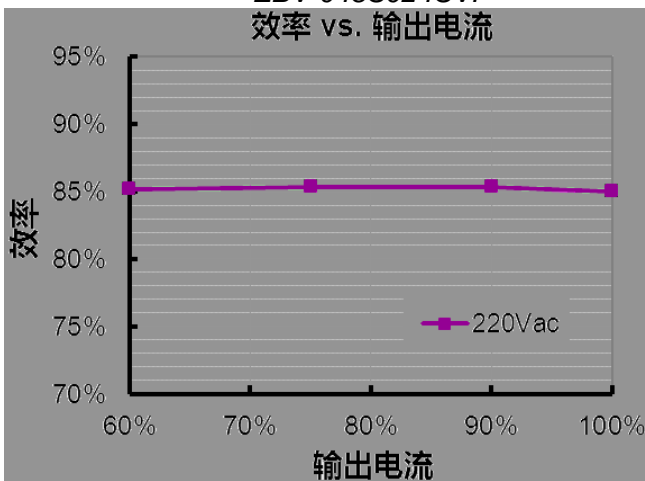

EBV-048S036SVF
效率 vs. 输出电流

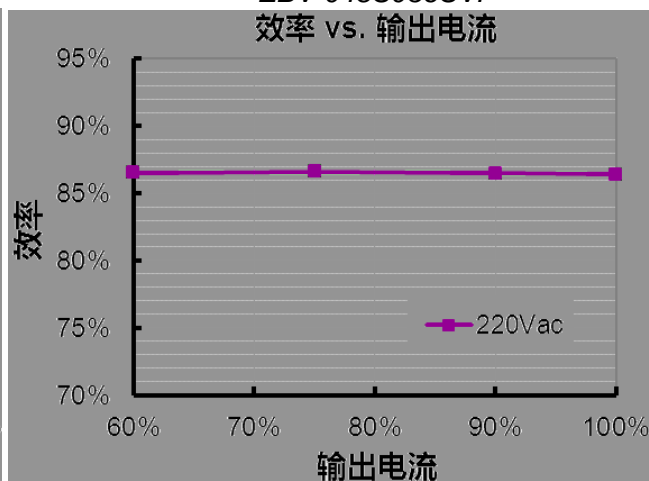

EBV-048S048SVF

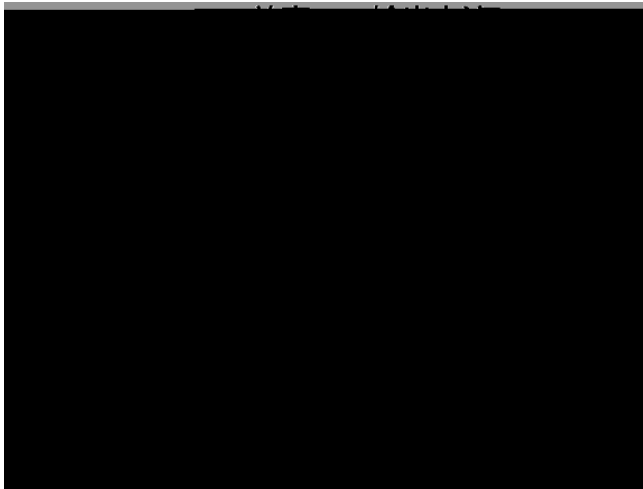

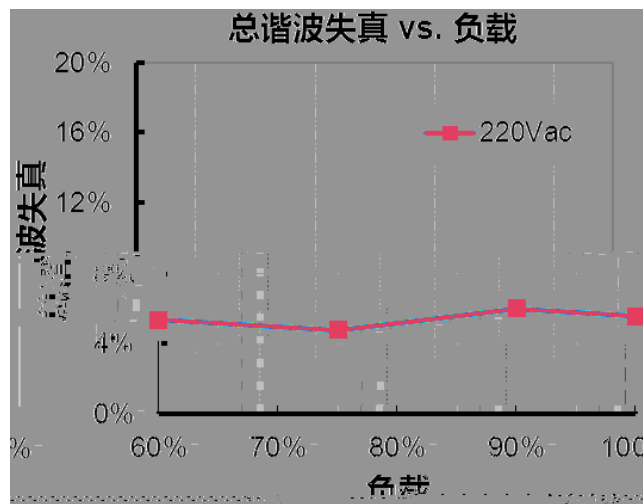
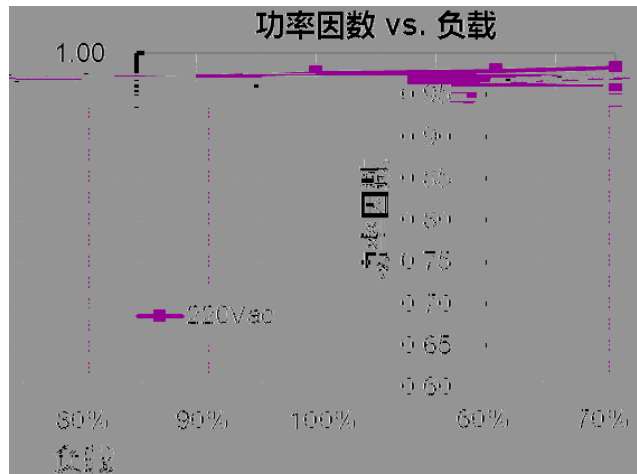

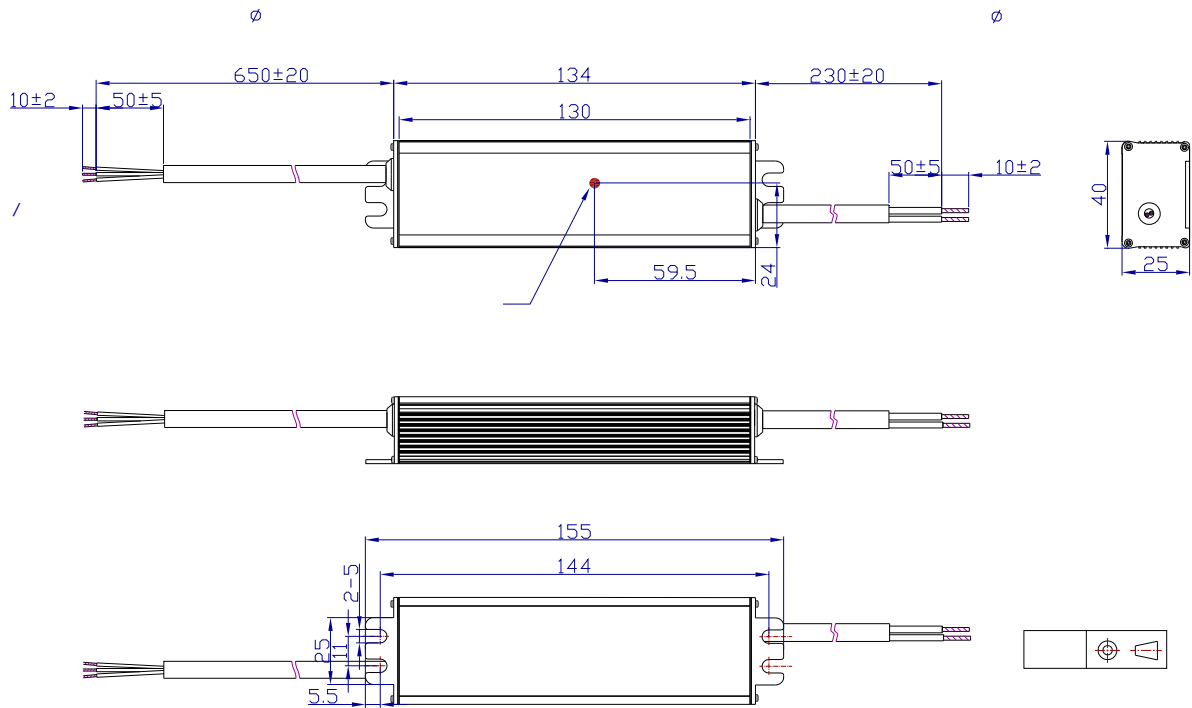

RoHS

RoHS 2011/65/EU

EU 2015/863

			/	/
			1 200-240Vac	1 CCC 220/230/240Vac; CCC 200-240Vac
			/	