

C | 4i

- x | ä ä
- x É 9 y ß
- x ... a' y [% Q < k » % Q <
- x ¶ • y' y v' k 9' k ? è' k "
- '
- x / 6
- x 9 + 2 <
- x v Å ' "



C | 5é

+ (< 9 ^ ^ 9 < , © ç = / 6 É 9 Ü ~ D } k ç y µ 9 8 < G I k Å Ä Ý ä ä
 œ fo ž 4 © ç D } © • % Å ç k x Ô Å ç C ö œ Å ç ^ • ò — ‹ ož Ý ä | ä k - Ø Û Ó — ‹ k ' ñ
 • ½ k â Ý ^ a U ä 4 D } U ' Å k w • x 4 D } . x ož ¶ • y ' k , ... a' o • v' o • 9'
 o • ? è' C " " k ¾ © ' š 4 4 . D } — ž I ô ož

1 Y æ =

Î Þ Ô 8	Î ' Ô 8 ÿ ¶	Î Þ Ô W ÿ	£ Ü Î Þ ' ¶] ' ß	´) d	1 Y
					¶	

l u g h))) • š 9 8 y < G I ! ")))) \$ Û • š 9 8 y < G l ož
 g h W • y µ 9 8 y < G I k ç < G I ¶ y µ 9 8 g i Ô - @ f t ' ì ¼ ç hož
 g h y i Ú ^ y < G I k ç ú g i Ô - @ f t • " hož

y µ 9 8					
y µ È ä 8					
¥ v					
y µ v				< G I k ç ú	

Î 4î x

? d	£ 3 š	À 1 š	£ Ü š	Ô I
~ ... v g / Zh				< G I k -ê "g Õ Ñ o h k / V Q / V Q k 4 Ò ž • # f Y z ! Õ Ñ @ f ~ ... v ¼ ž
ä œ f				ž ú
È ´ f â 1				g h

Î Þ 4î x

? d	£ 3 š	À 1 š	£ Ü š	Ô I
ÿ ß 9 ð †				ž ú
È ÿ ß 9 ¼ f				ž ú ož " P f ~ 3 . ` k ! Ú ^ k ÿ ß w Ä f , G Ì y f , † ož
o ï 9				ž ú
ž À² ... ä				ž ú
ž ú² ... ä				
• Ñ o ž •				< G I k ž ú
Á € •	ÿ ß ž [ž • ' ž • y µ
	û 3 ž •			ž ú y ž ú
" † © f		q		Ó " q Á Ý ›

l u ñ Ä Å @ f ® " † q Õ Ñ ñ O y Á ° › k Ô ð h ç " Û ož

P á é

? d	£ 3 š	À 1 š	£ Ü š	Ô I
ä				ž ú k q ê "
u ® — { ž ž •				< G I k ê " - k ž ú 3 / 2 . * (1 ,
. x ž •				< G I k ž ú k Ó " - k ! Õ Ñ @ f . x ¼ ž

P á é

¿ d	£ 3 š	À 1 š	£ Ü š	Ô I
• Ó “				
À ‘ Ó “			q	v À ‘ ñ + • À ‘ Ó “ ~ t y
¥ “ †				~ t y
> * 6 * 2 ~ = ~ . D œ 2 ~ = ~ .				m 5 ö > * ^ ^ ^ ^
Ô M				

I u ñ Ā Ā @ f ® “ † q Õ Ñ ñ O y Á ° › k Ô ð h ç “ Û o ž

μ Ô Ā × Ô

μ ù ç	× Ô
+ 3 / × Ô	Ô I
⊠ × Ô	Ô I

μ Ô Â × Ô

x Ô	Ô I

Iu g h › á +3/ ö Ö k x 9 › • ° À © Ī %² B ä k - È ` ° À Ä € - Ö g +3/ , ¼ G • ož

· › • Ž

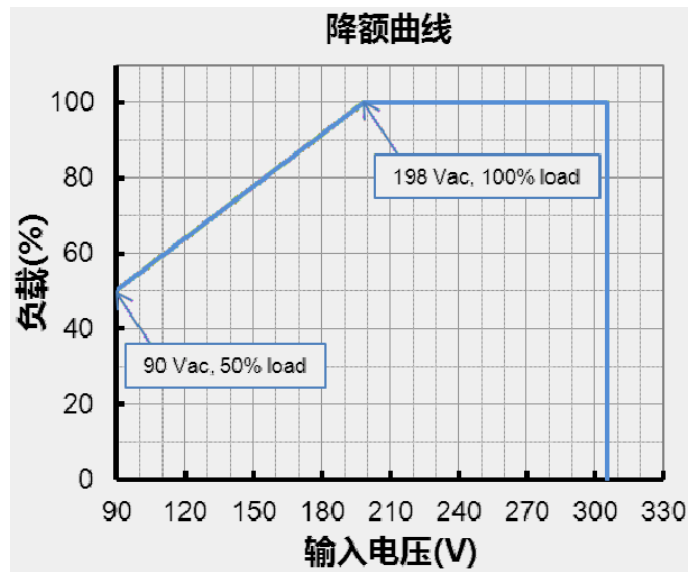

- w * Ô t • Ž

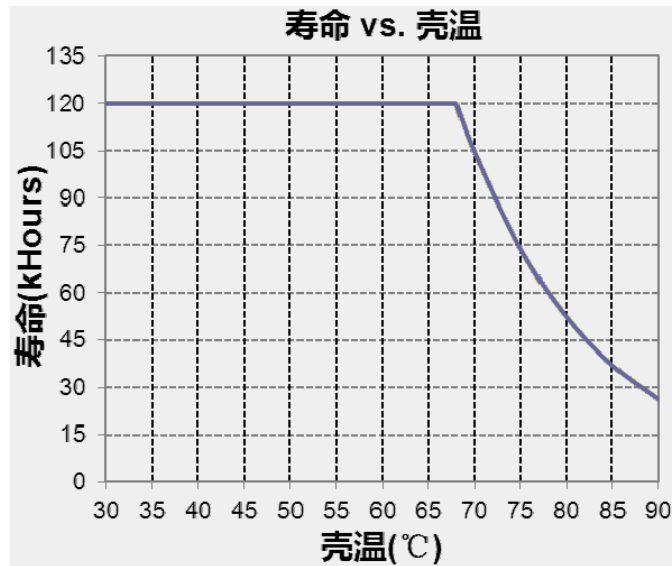

↳ d • Ž

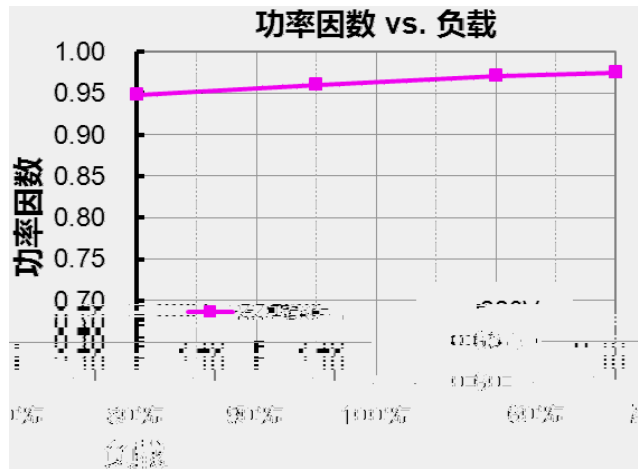

5 f G á • Ž

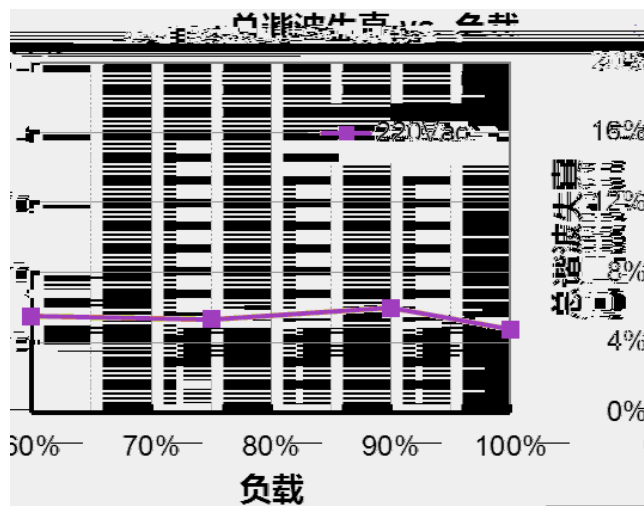

• õ x

?	?
v'	Ê Ö % "ož { ž L " ž k Ê Öož
g'	y ß 9 k ' ò " • 8 Äož
? è'	Ê Ö % "ož ? è ž k D } — C oož ? è L " ž k U Ê Öož
" "	Ê Ö % "ož " † " ž k U Ê Ö 3 oož

2 Ä ø

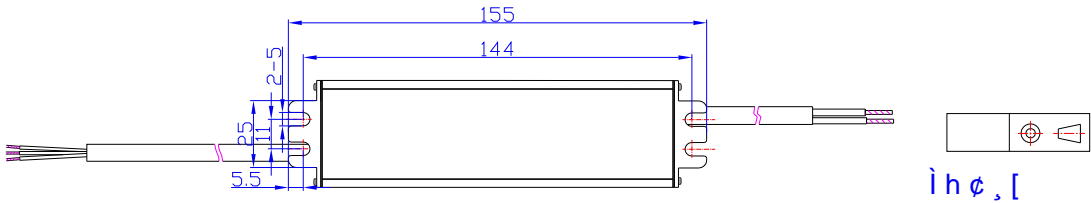
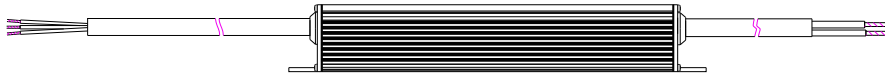
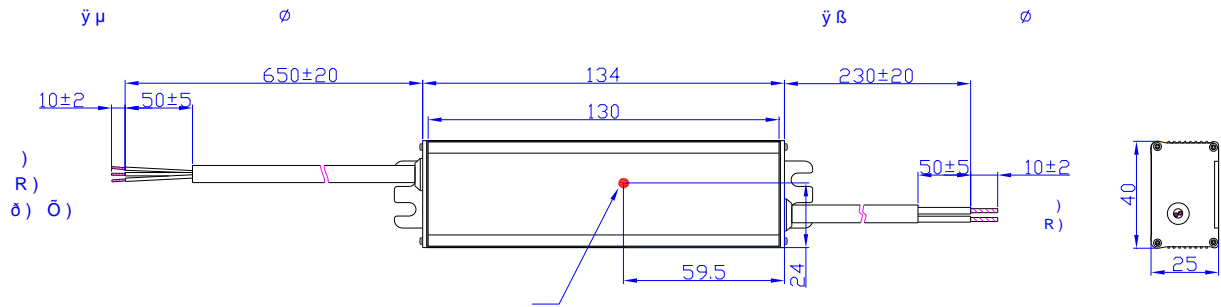

T_ 8 U. 9 L-

é[D}...` , (8 U. 9 6 X

+ ; C ç Â • “ œ 6 X g + ; h

ož

'[bø

'X•N	•-	'X5é		
		•ù	Q	è
		Gg		
		°ZçnÕh	g h•š 98 y < G lož	g h))) •š 98 y < G I! "))) \$Ù •š 9 8 y < G lož
		Ñã£		¾•