

- 
- 
- 
- 
- 
- 
- 
- 
- 
- 
- 

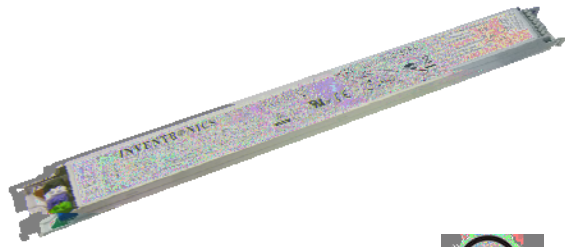

	(1)		(2)			(3)			(4)
							120Vac	220Vac	
19.3-550mA	385-550mA	530mA	90~305 Vac 127~300 Vdc	31~156 Vdc	60 W	90%	0.99	0.96	LUD-060S055BS2
27.3-780mA	546-780mA	700mA	90~305 Vac 127~300 Vdc	22~110 Vdc	60 W	90%	0.99	0.96	LUD-060S078BS2 <sup>(5)</sup>
38.5-1100mA	770-1100mA	1050mA	90~305 Vac 127~300 Vdc	16~78 Vdc	60 W	90%	0.99	0.96	LUD-060S110BS2 <sup>(5)</sup>
52.5-1500mA	1050-1500mA	1400mA	90~305 Vac 127~300 Vdc	12~57 Vdc	60 W	89%	0.99	0.96	LUD-060S150BS2 <sup>(6)</sup>
73.5-2100mA	1470-2100mA	2100mA	90~305 Vac 127~300 Vdc	8~40 Vdc	60 W	89%	0.99	0.96	LUD-060S210BS2



**LUD-060SxxxBS2**

**Rev. C**

**60W IP20**

**DALI**

(pk-pk)	-	5%I <sub>omax</sub>	10%I <sub>omax</sub>	20 MHz BW
	-	1%I <sub>omax</sub>	5%I <sub>omax</sub>	
	-	-	10%I <sub>omax</sub>	
LUD-060S055BS2	-	-	180 V	
LUD-060S078BS2	-	-	120 V	
LUD-060S110BS2	-	-	90 V	
LUD-060S150BS2	-	-	59.5 V	
LUD-060S210BS2	-	-	50 V	
	-	-	± 0.5%	
	-	-	± 1.5%	
	-	0.5 s	1.0 s	65%-100%
	-	0.3 s	0.5 s	65%-100%
	-	-	0.02%/°C	°C
	10.8 V	12 V	13.2 V	
	0 mA	-	200 mA	

°

@120Vac:				
LUD-060S055BS2	I <sub>o</sub> =385 mA	86.0%	88.0%	-
	I <sub>o</sub> =550 mA	85.0%	87.0%	-
LUD-060S078BS2	I <sub>o</sub> =546 mA	86.0%	88.0%	-
	I <sub>o</sub> =780 mA	85.0%	87.0%	-
LUD-060S110BS2	I <sub>o</sub> =770 mA	86.0%	88.0%	-
	I <sub>o</sub> =1100 mA	84.0%	86.0%	-
LUD-060S150BS2	I <sub>o</sub> =1050 mA	85.0%	87.0%	-
	I <sub>o</sub> =1500 mA	84.0%	86.0%	-
LUD-060S210BS2	I <sub>o</sub> =1470 mA	85.0%	87.0%	-
	I <sub>o</sub> =2100 mA	83.0%	85.0%	-

<b>@220Vac:</b>				
LUD-060S055BS2	Io=385 mA	88.0%	90.0%	-
	Io=550 mA	87.0%	89.0%	-
LUD-060S078BS2	Io=546 mA	88.0%	90.0%	-
	Io=780 mA	87.0%	89.0%	-
LUD-060S110BS2	Io=770 mA	88.0%	90.0%	-
	Io=1100 mA	86.0%	88.0%	-
LUD-060S150BS2	Io=1050 mA	87.0%	89.0%	-
	Io=1500 mA	86.0%	88.0%	-
LUD-060S210BS2	Io=1470 mA	87.0%	89.0%	-
	Io=2100 mA	85.0%	87.0%	-
<b>@277Vac:</b>				
LUD-060S055BS2	Io=385 mA	88.0%	90.0%	-
	Io=550 mA	87.0%	88.5%	-
LUD-060S078BS2	Io=546 mA	88.0%	90.0%	-
	Io=780 mA	87.0%	89.0%	-
LUD-060S110BS2	Io=770 mA	88.0%	90.0%	-
	Io=1100 mA	86.0%	88.0%	-
LUD-060S150BS2	Io=1050 mA	87.0%	89.0%	-
	Io=1500 mA	86.0%	88.0%	-
LUD-060S210BS2	Io=1470 mA	87.0%	89.0%	-
	Io=2100 mA	85.0%	87.0%	-
	-	-	0.5 W	
	-	220,000 Hours	-	
	-	107,000 Hours	-	
	-30°C	-	+85°C	
	-30°C	-	+70°C	10% RH to 90% RH.
	-30°C	-	+85°C	: 5% RH to 90% RH.
	-	370 g	-	

DA/P, DA/P	9.5V	16V	22.5V	
DA/P, DA/P	-6.5V	0V	6.5V	
DA/P, DA/P	0mA	-	2mA	
	5%loset	-	loset	70%lomax ≤ loset ≤ 100%lomax
	3.5%lomax	-	loset	3.5%lomax ≤ loset < 70%lomax

○

UL/CUL	UL 8750,UL1310,CAN/CSA-C22.2 No. 250.13,CAN/CSA-C22.2 No. 223-M91
CE & TUV & ENEC	EN61347-1 <sup>(1)</sup> , EN61347-2-13
CB	IEC 61347-1, IEC 61347-2-13
PSE	J 61347-1, J 61347-2-13
KS	KS C 7655
<b>EMI</b>	
EN 55015 <sup>(2)</sup>	Conducted emission Test & Radiated emission Test
EN 61000-3-2	Harmonic current emissions Class C
EN 61000-3-3	Voltage Fluctuations & Flicker
FCC Part 15 <sup>(2)</sup>	ANSI C63.4 Class B
	This device complies with Part 15 of the FCC Rules. Operation is subject to the following two conditions: [1] this device may not cause harmful interference, and [2] this device must accept any interference received, including interference that may cause undesired operation.
J 55015	Limits and methods of measurement of radio disturbance characteristics of electrical lighting and similar equipment
<b>EMS</b>	
EN 61000-4-2	Electrostatic Discharge(ESD): 8 kV air discharge, 4 kV contact discharge
EN 61000-4-3	Radio-Frequency Electromagnetic Field Susceptibility Test-RS
EN 61000-4-4	Electrical Fast Transient/Burst-EFT
EN 61000-4-5	Surge Immunity Test: AC Power Line: line to line 1 kV

<b>EMS</b>	
EN 61000-4-6	Conducted Radio Frequency Disturbances Test-CS
EN 61000-4-8	Power Frequency Magnetic Field Test
EN 61000-4-11	Voltage Dips
EN 61547	Electromagnetic Immunity Requirements Applies to Lighting Equipment
<b>DALI</b>	
DALI	IEC62386-101,102 & part of 207 <sup>(3)</sup>

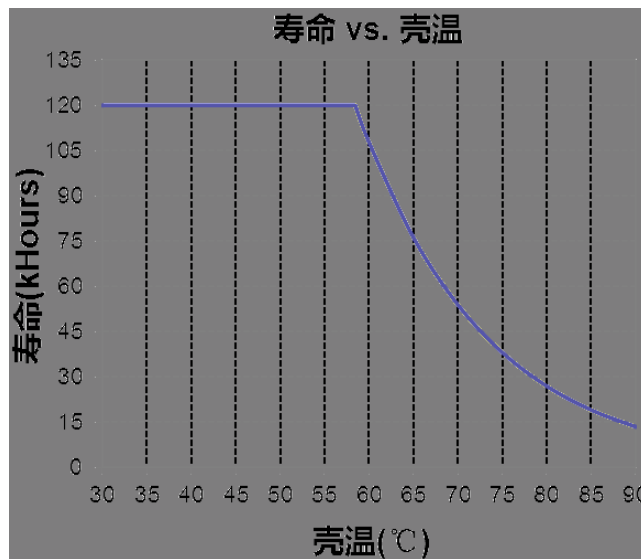

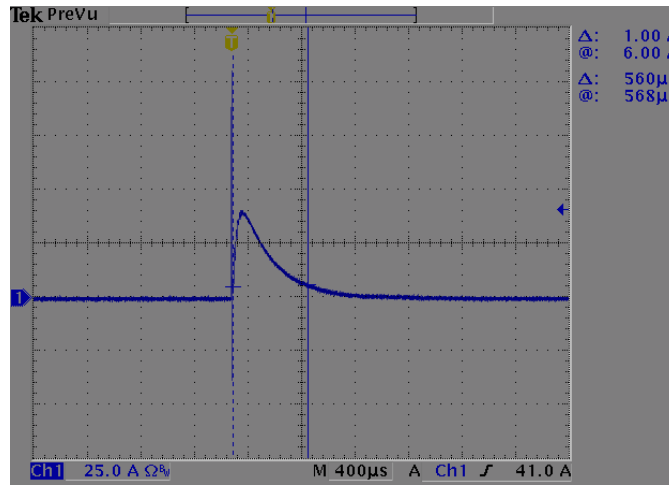

LUD-060S055BS2 (Io=385mA)

效率 vs. 输出电压

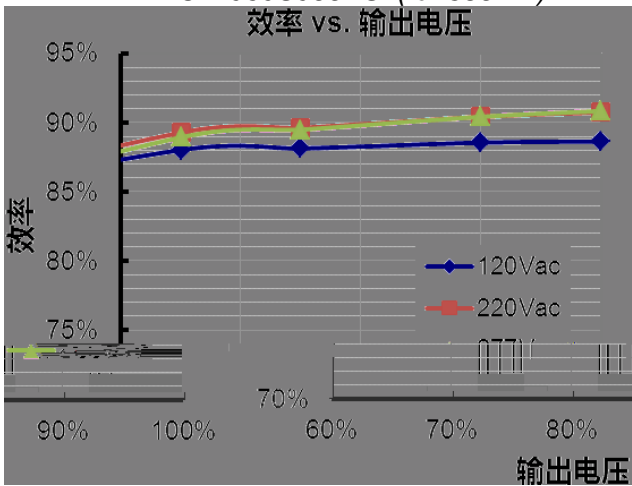

LUD-060S055BS2 (Io=550mA)

效率 vs. 输出电压

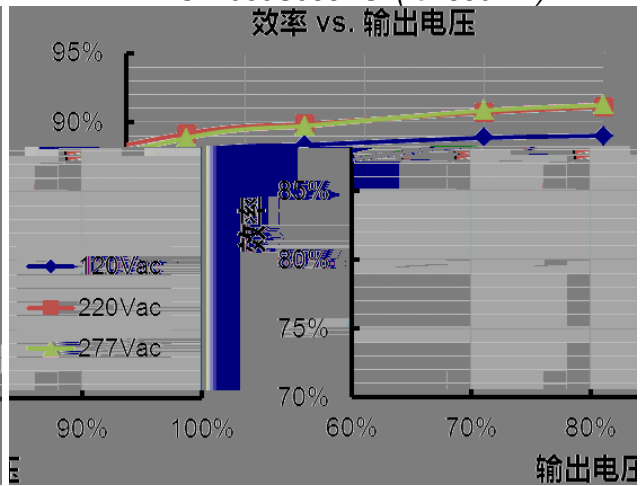

LUD-060S078BS2 (Io=546mA)

效率 vs. 输出电压

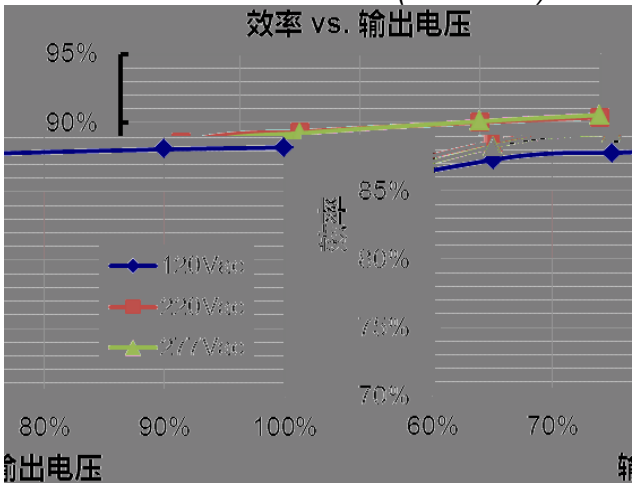

LUD-060S078BS2 (Io=780mA)

效率 vs. 输出电压

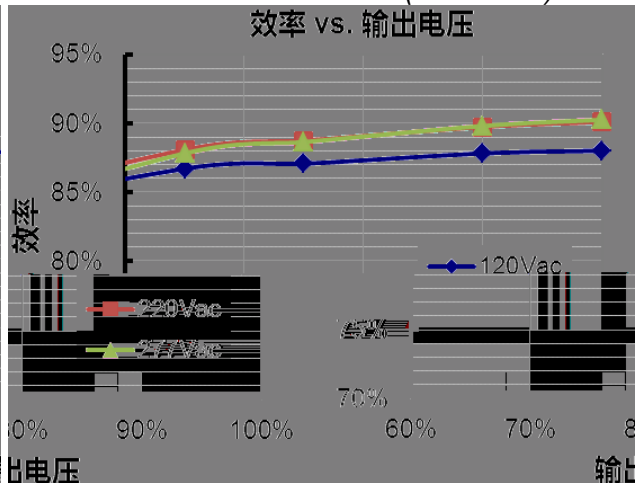

LUD-060S110BS2 (Io=770mA)  
效率 vs. 输出电压

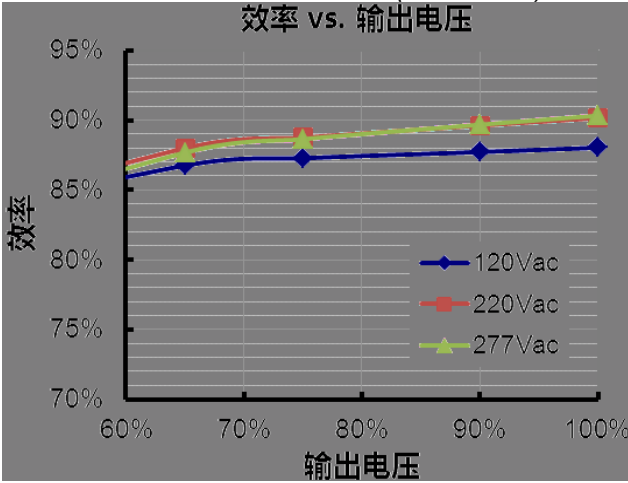

LUD-060S110BS2 (Io=1100mA)  
效率 vs. 输出电压

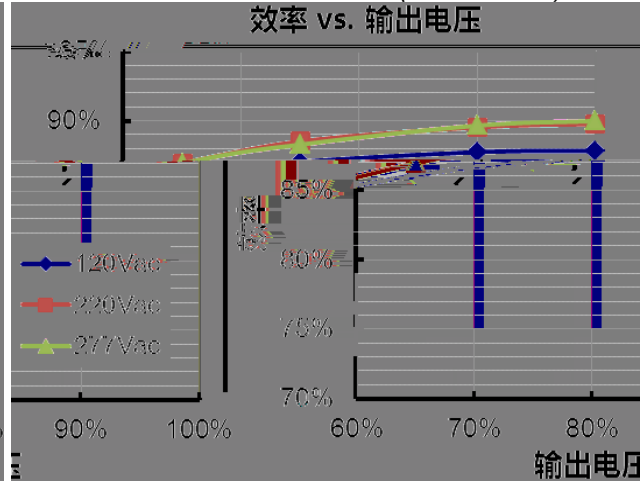

LUD-060S150BS2 (Io=1050mA)  
效率 vs. 输出电压

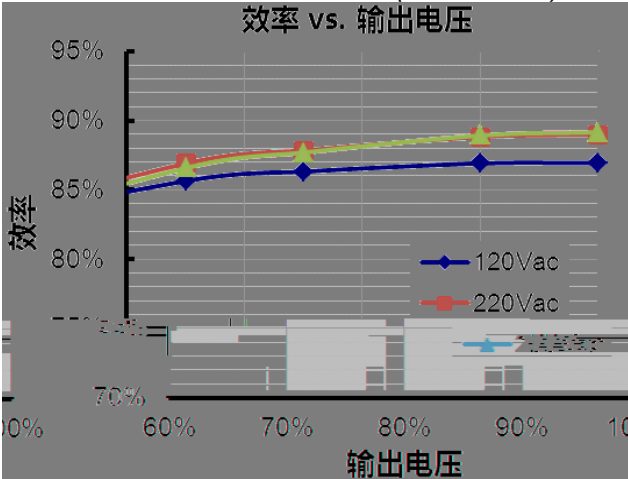

LUD-060S150BS2 (Io=1500mA)  
效率 vs. 输出电压

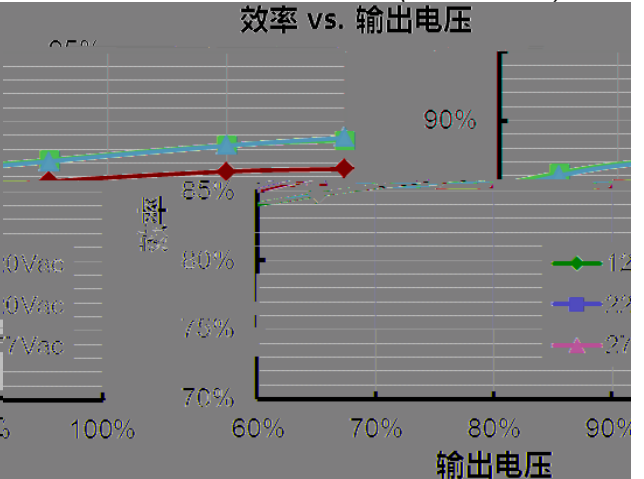

LUD-060S210BS2 (Io=1470mA)  
效率 vs. 输出电压

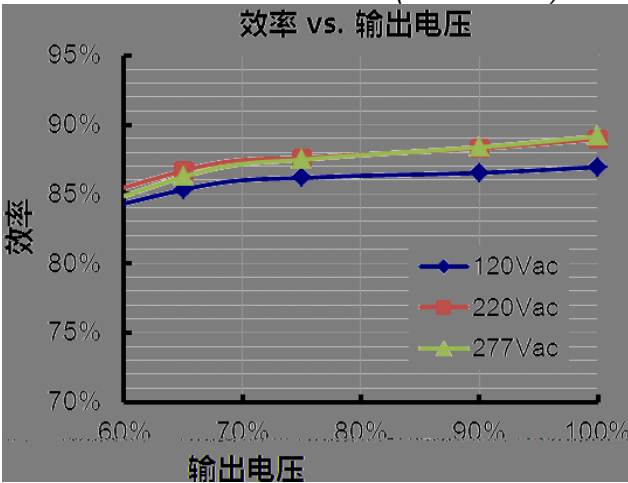

LUD-060S210BS2 (Io=2100mA)  
效率 vs. 输出电压

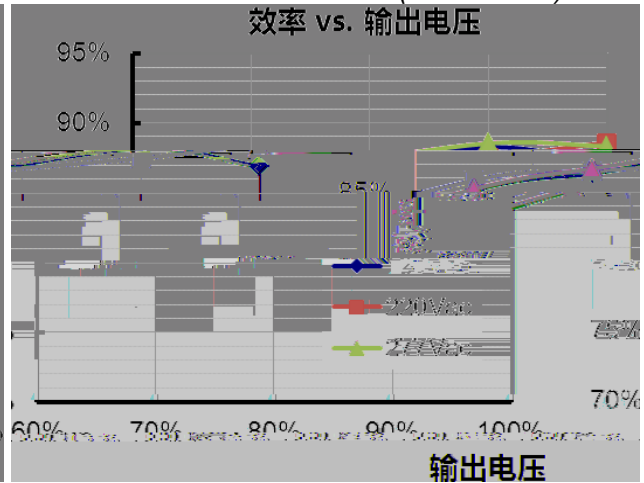



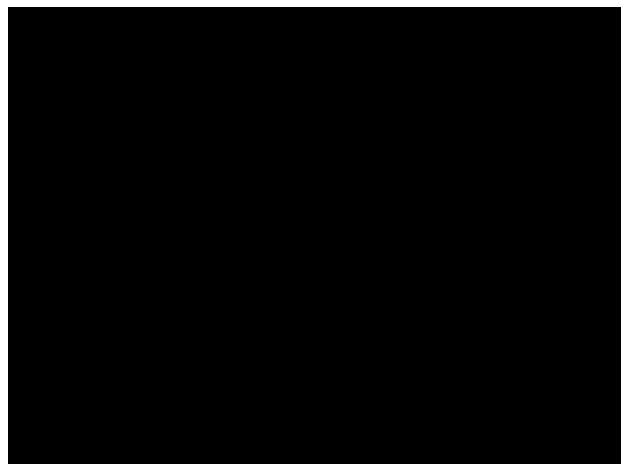
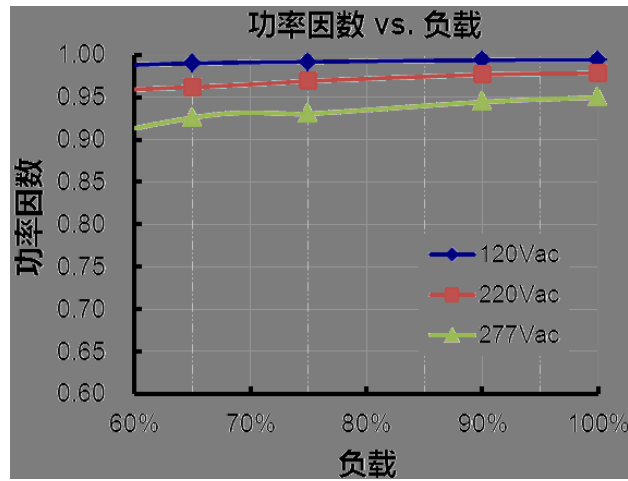

	R1	-	7.81kOhm	-	
	R2	-	4.16 kOhm	-	
		10%loset	60%loset	100%loset	10%loset > lomin ( 60%)
		lomin	60%loset	100%loset	10%loset ≤ lomin ( 60%)

● DALI

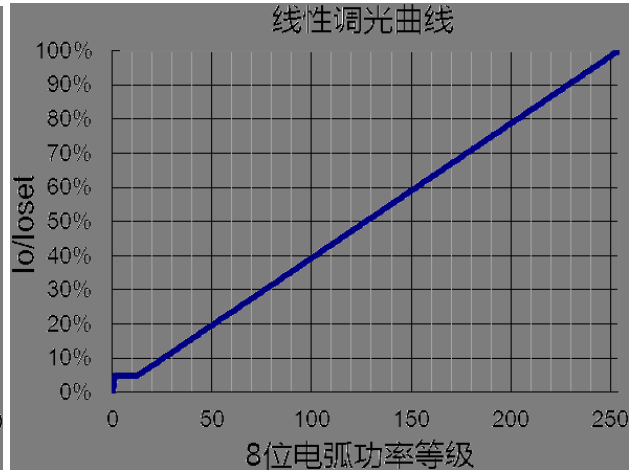
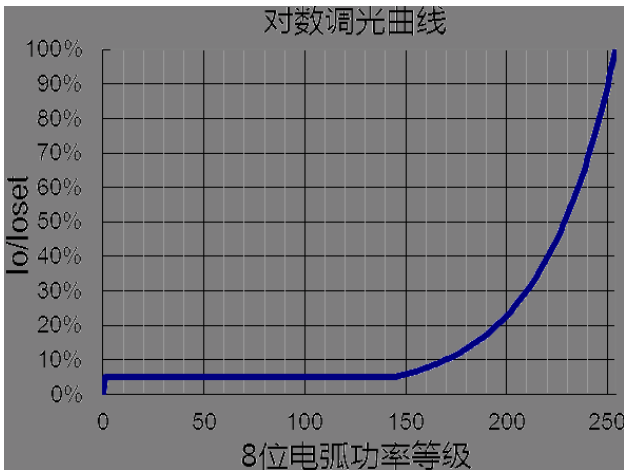
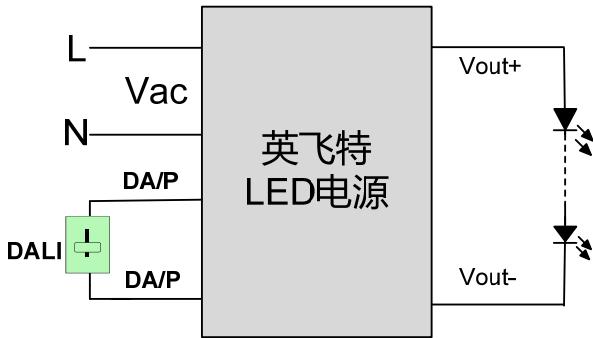

DALI

●

	90 V	-	264 V	
	5%IoSet	-	IoSet	70%Iomax ≤ IoSet ≤ 100%Iomax
	3.5%Iomax	-	IoSet	3.5%Iomax ≤ IoSet < 70%Iomax
	0.1 s	-	0.6 s	
	0.6 s	-	3.6 s	(
	0.6 s	-	6.6 s	
	10 s	-	-	

- 

	20 s	-	-	

DALI

- DALI



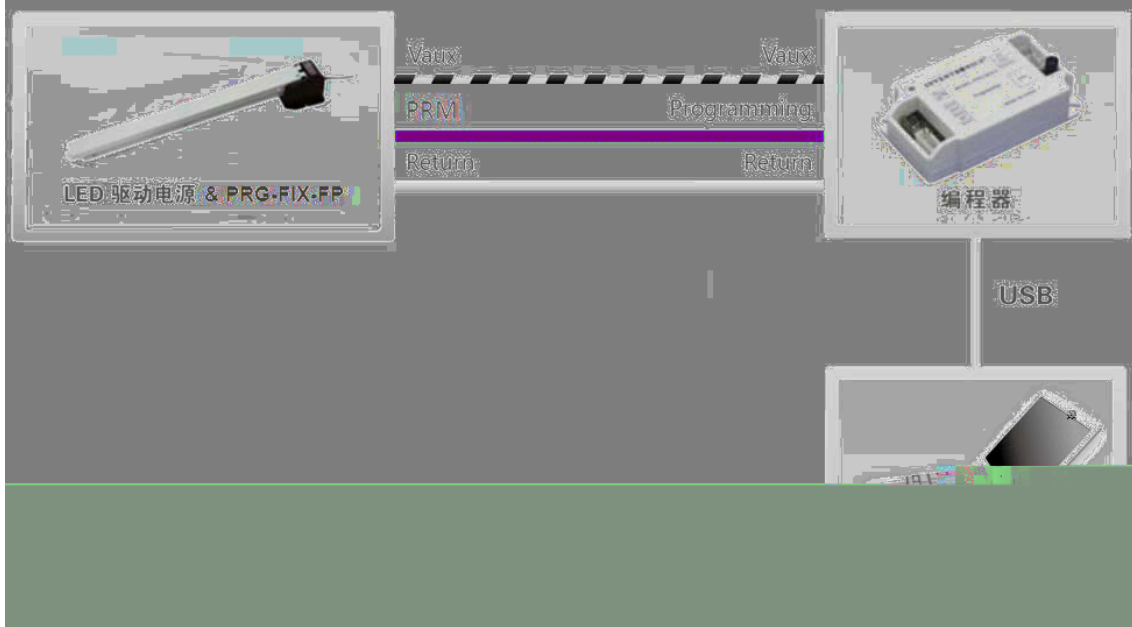

- 

[PRG-FIX-FP](#)

[PRG-MUL2](#)



2016-05-06	A		/	/	
2016-10-24	B		/		
			/		
2019-01-31	C		/		
				/	
				/	
		/			
		/			