

# CNV-DMXR

	.....	1
1	.....	1
1.1	.....	1
1.2	.....	1
1.3	.....	1
2	.....	2
2.1	.....	2
2.2	.....	2
3	.....	3
3.1	.....	3
3.2	.....	3
4	.....	4
4.1	.....	4
5	.....	5
5.1	.....	5
5.1.1	USB .....	5
5.1.2	.....	7
6	.....	8

6.1	.....	8
6.2	.....	9
6.3	.....	10
6.4	.....	11
6.5 DMX512	.....	12
6.6 DMX512	.....	13
6.7 DMX512	.....	14
6.8	.....	15

# 1

## 1.1

CNV-DMXR

## 1.2

DMX512

(USITT)

CNV-DMXR

DMX512

0-10V

RDM

CNV-DMXR

## 1.3

DMX (Digital Multiple X)

DMX512: **512**

RDM (Remote Device Management)

DMX512-A

CNV-DMXR **DMX512**

**0-10V**

## 2.

### 2.1

### 2.2

- 1.
- 2.
3. DMX512
4.     DMX512
- 5.

# 3.

## 3.1

1GHz                      32

512Mb                  RAM

20GB

UTEK UT890

CNV-DMXR

## 3.2

Windows XP    Windows 7

Microsoft .NET Framework 4.0

# 4

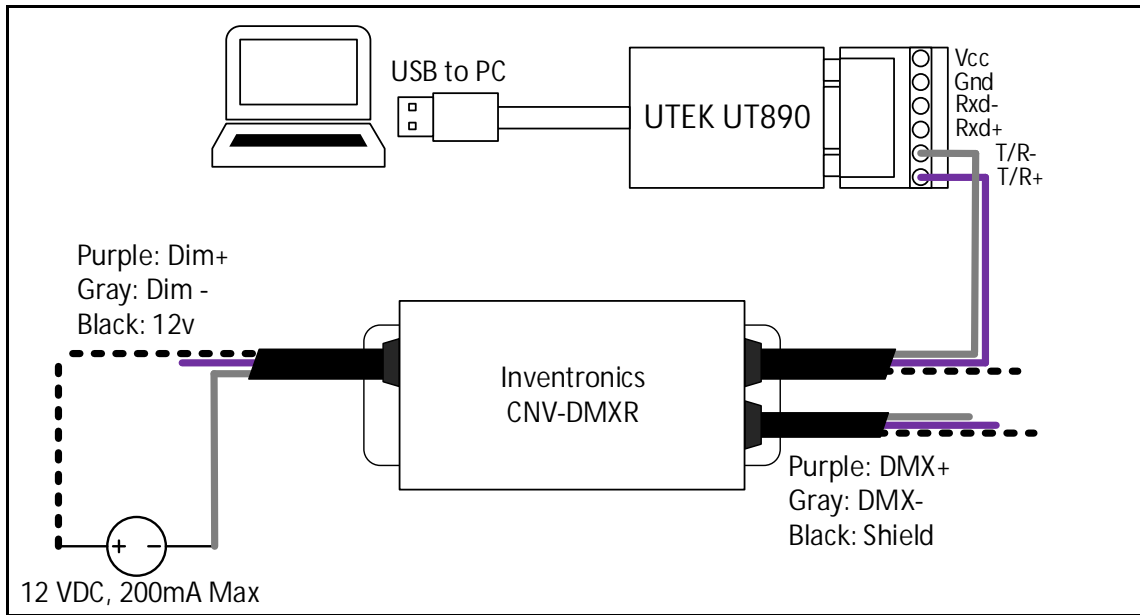

## 4.1

1. CNV-DMXR UTEK UT890

a. CNV-DMXR Data+ UTE890 T/R+

b. CNV-DMXR Data- UTE890 T/R-

\* CNV-DMXR DMX UTE890

c. Dim- DC 12VDC- 12VDC-

d. Vaux DC 12VDC+ 12VDC-

e. CNV-DMXR 200mA

2. CNV-DMXR

# 5.

## 5.1

### 5.1.1 USB

1. USB\_MCom.rar
2. USB\_MCom.exe
- 3.

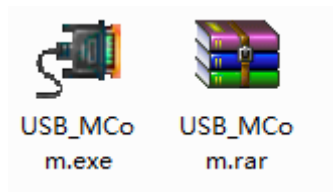

4.4.1.1 USB

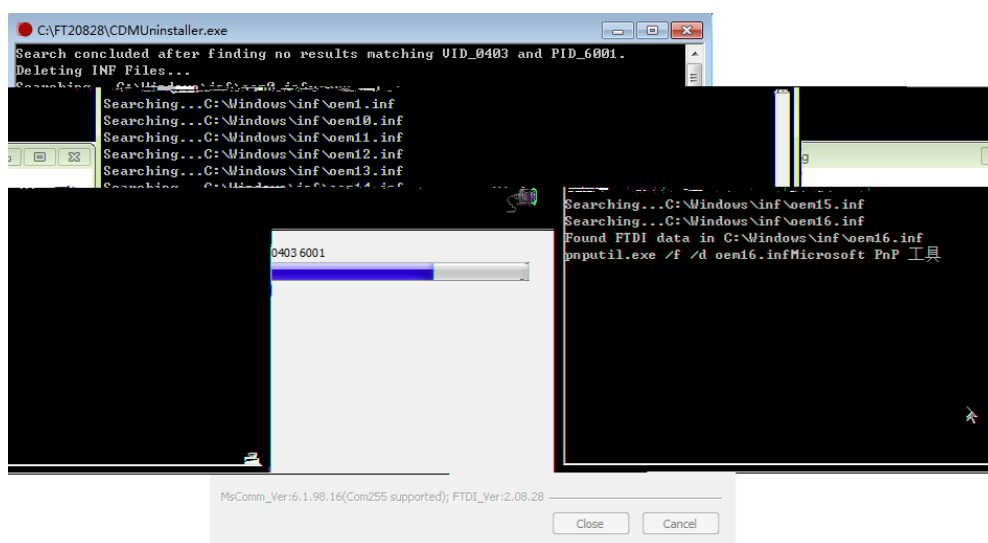

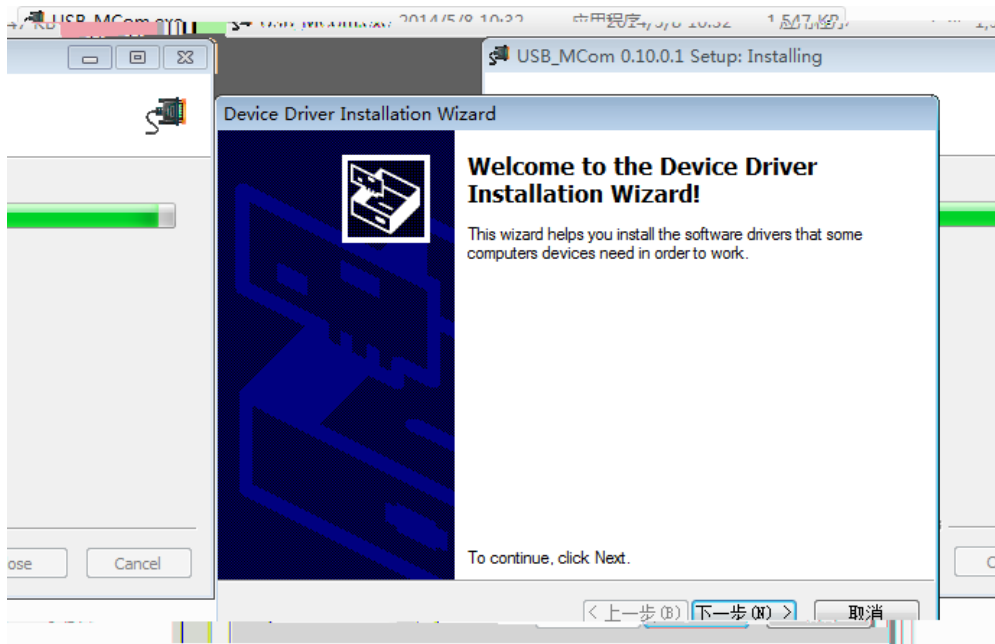



## 5.1.2

1.

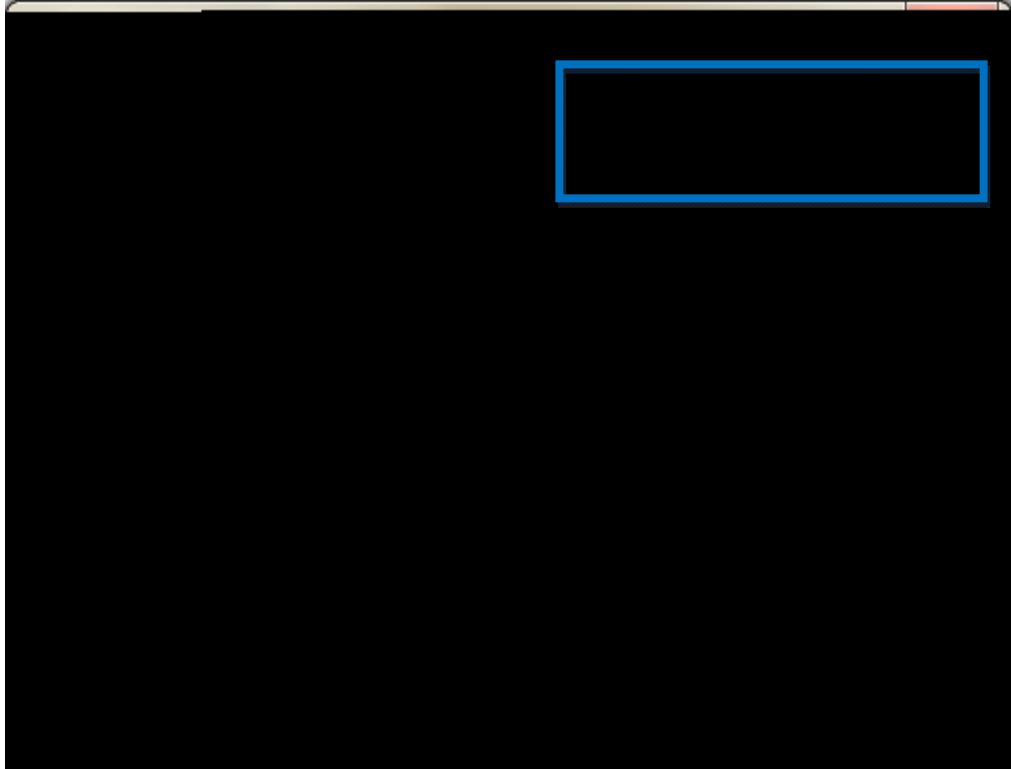

2. PC Microsoft .NET Framework 4.0

<https://www.microsoft.com/zh-cn/download/details.aspx?id=17718>

6.

6.1

## 6.2

COMx x

USB

Port

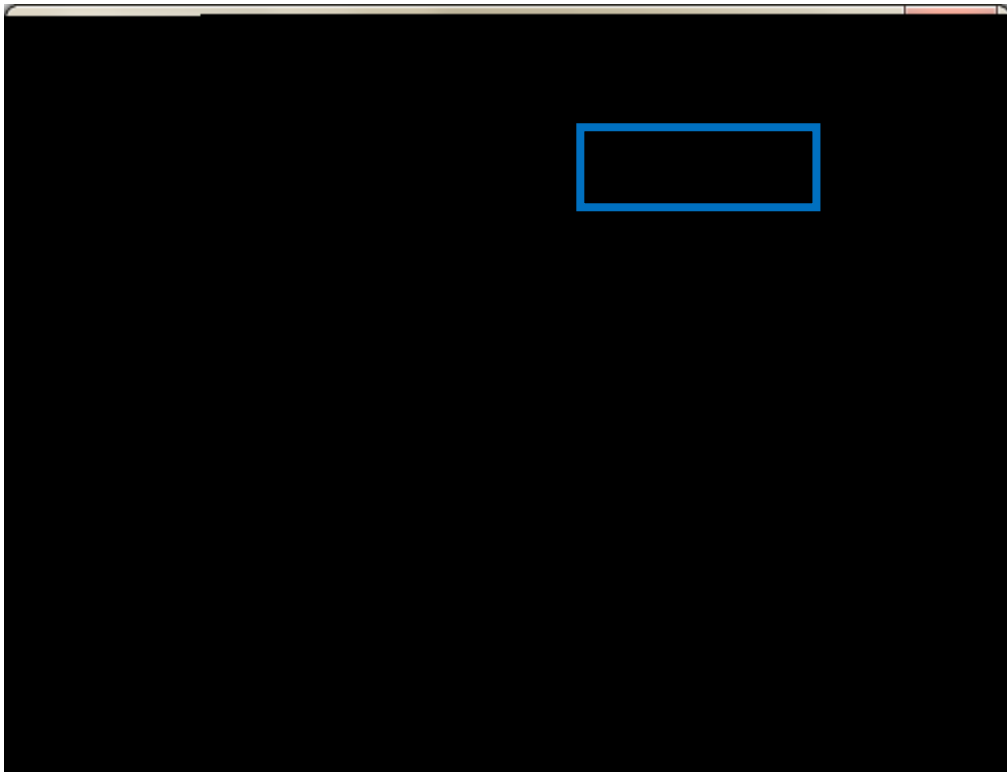

## 6.3

- 1 Read Curve ( )
- 2 CNV-DMXR
- 3

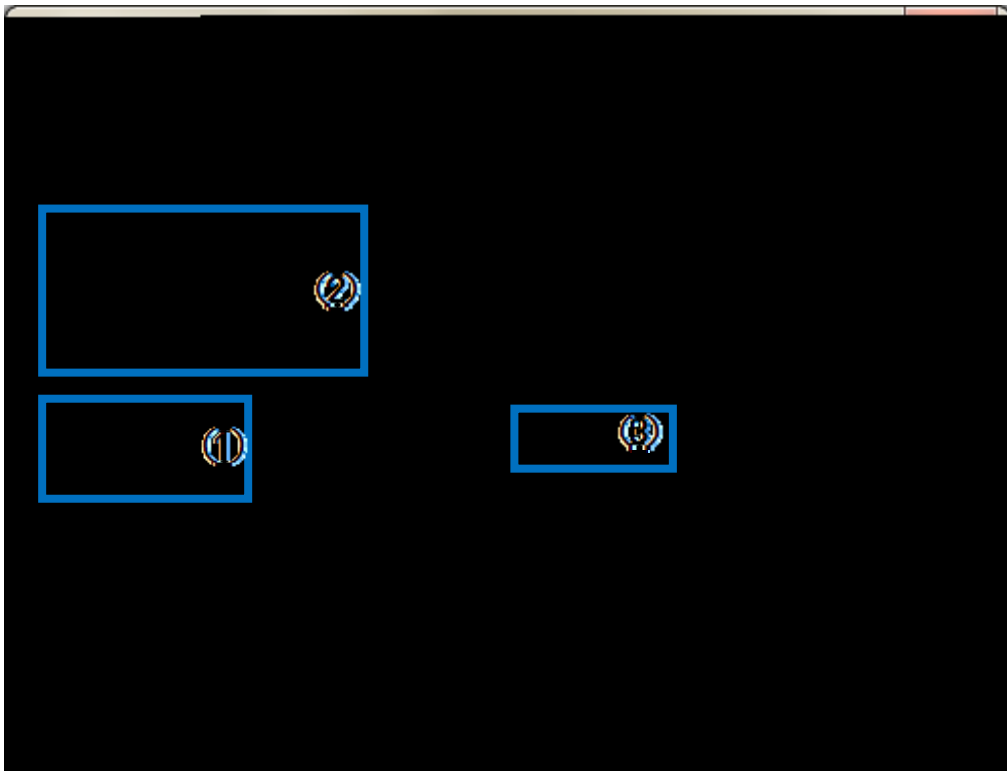

## 6.4

1

2 Write Curve ( )

3

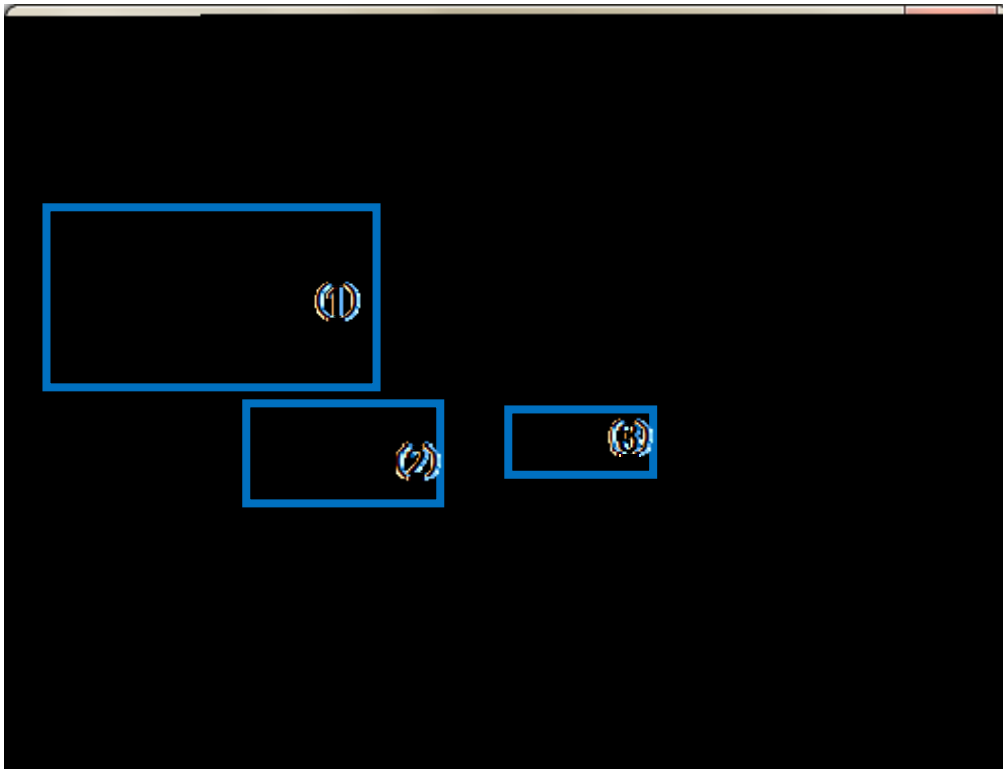

## 6.5 DMX512

- 1 Read Address ( )
- 2 CNV-DMXR
- 3

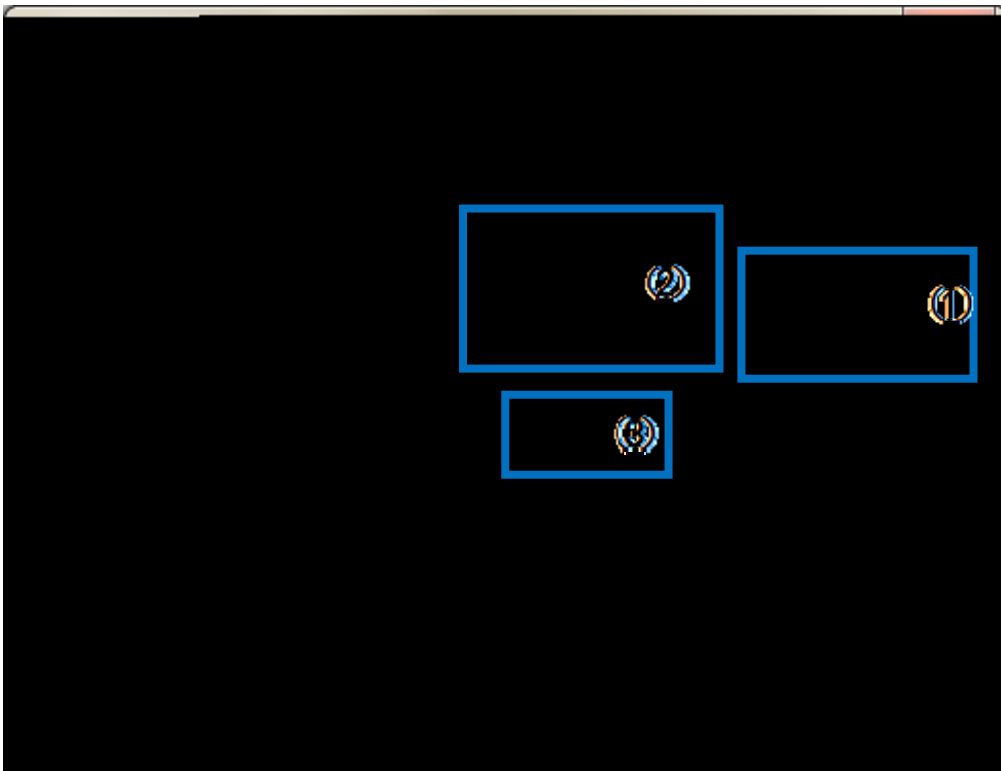

## 6.6 DMX512

- 1 DMX512
- 2 Write Address ( )
- 3

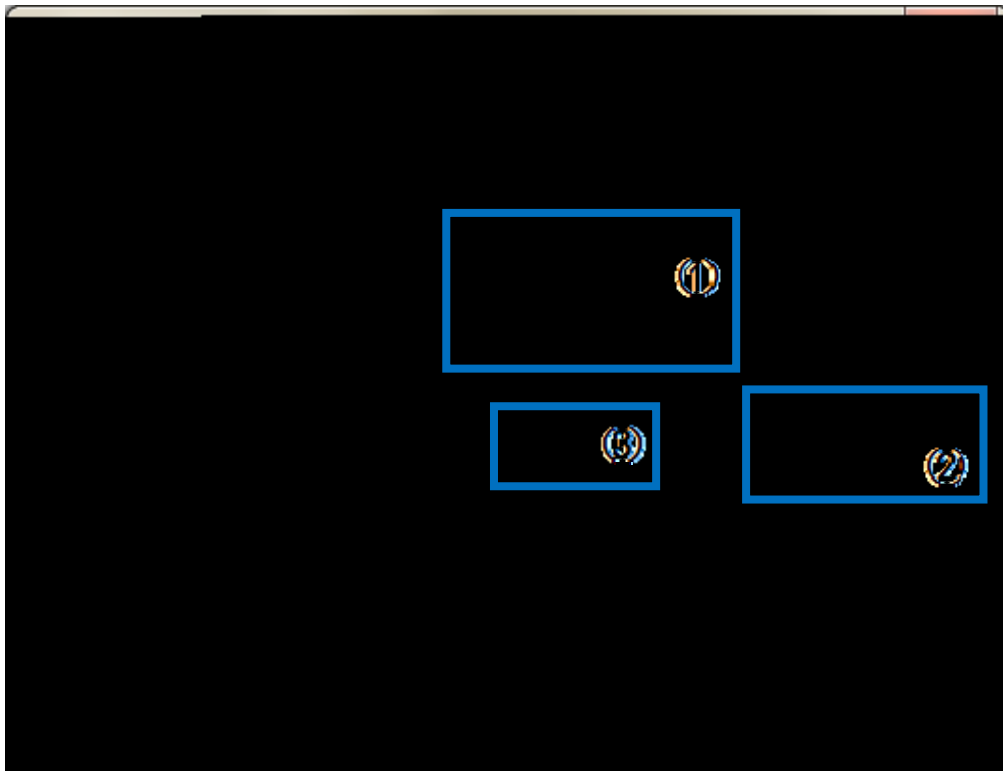

## 6.7 DMX512

1

2

3 Dimming( )

4

1 512 ( )  
( ) 0

2 CNV-DMXR DMX512

[5.5 DMX512](#)

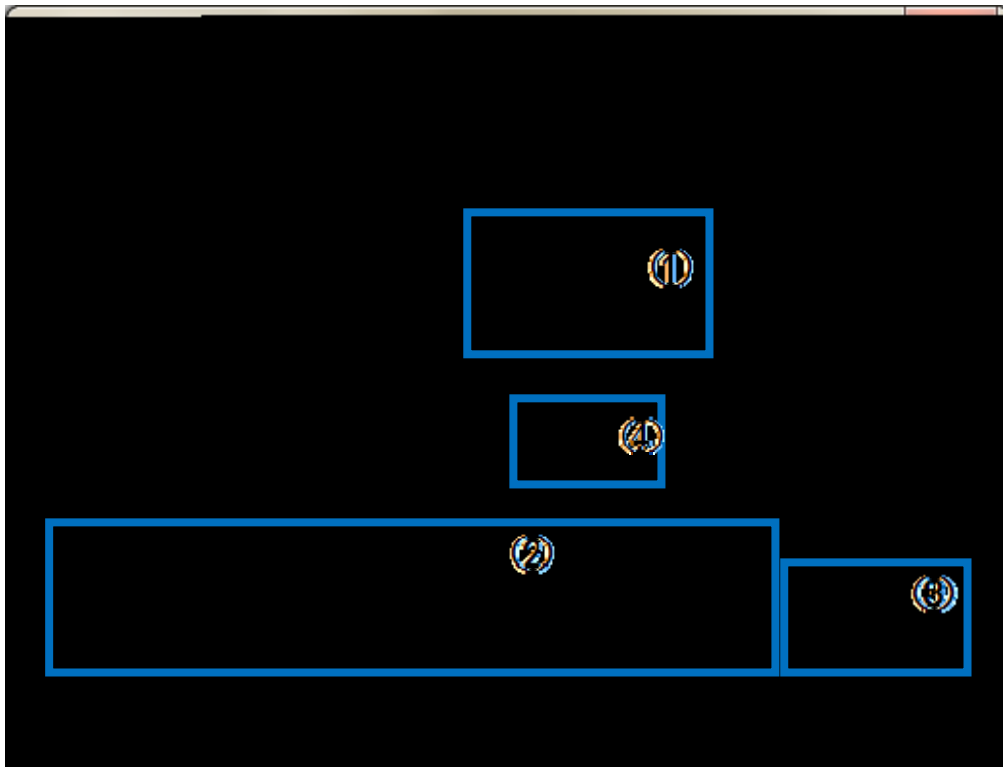



## 6.8

CNV-DMXR

Alt

- 1 Read Address ( ) R
- 2 Write Address ( ) W
- 3 Dimming ( ) D
- 4 F1

