

NES-1K8-BC

LED

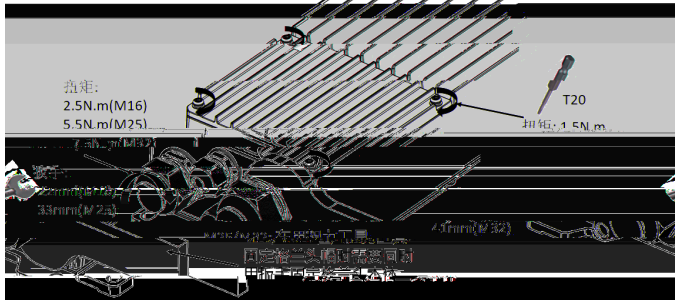

	1.5 N.m	T20
	2.5 N.m	22mm
	5.5 N.m	33mm
	7.5 N.m	41mm

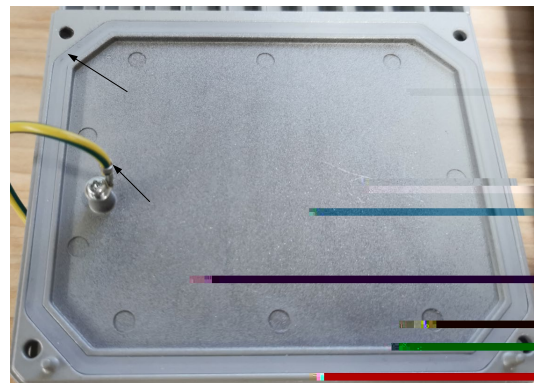
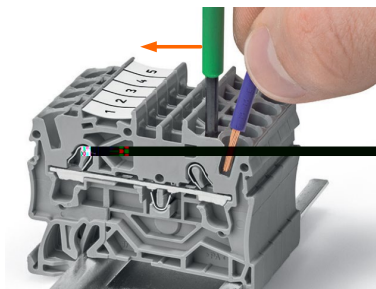

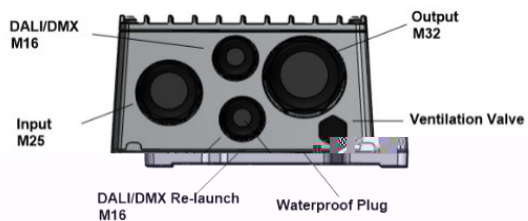

接头位置	格兰头	插距 (mm)	直径 (mm)	线径 AWG	截面积 (mm ²)
AC 输入	M25	5.5	13-18	18-12	1.5-2.5
DC 输出	M32	7.5	15-21	18-12	1.5-2.5
DALI/DMX	M16	2.5	12-18	18-12	1.5-2.5
0.75-2.5	DALI/DMX 级联	M16	2.5	5-10	18-12

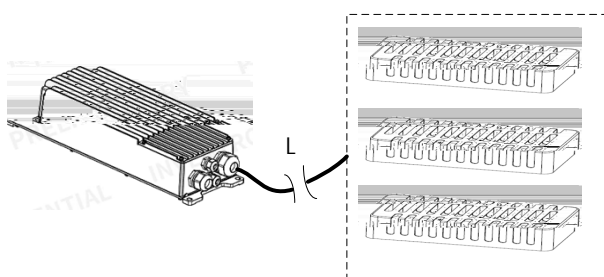

L < 100m 1.5 mm²
 100 m < L < 300m: 2.5 mm²

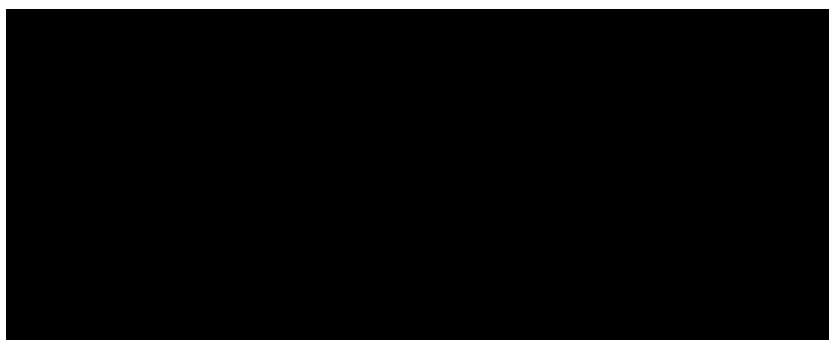

NES-1K8T210BC

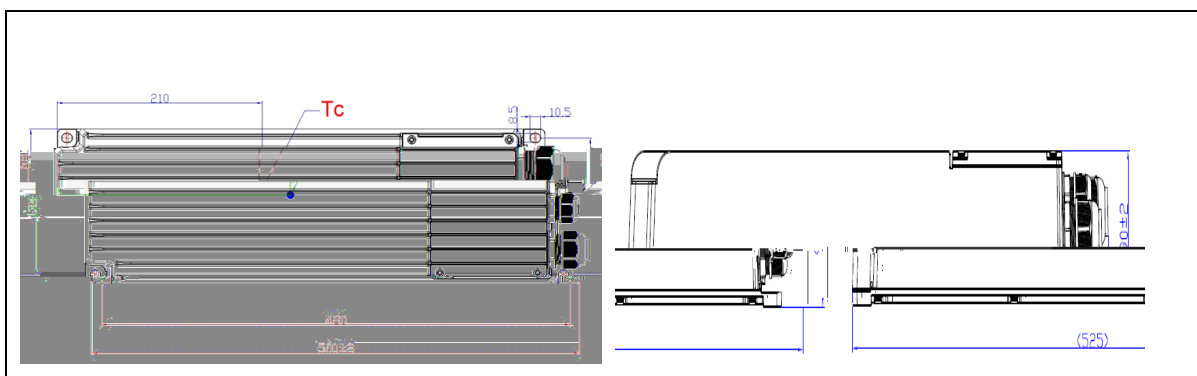

LED

80°C

220	5.8	11200
400	12	6800

B6	0	0
B10	0	0
B16	1	1+1+1
B20	1	1+1+1
B25	1	1+1+1
B40	2	2+2+2
C6	0	0
C10	0	0
C16	1	1+1+1
C20	1	1+1+1
C25	2	2+2+2
C40	3	3+3+3

LED

<https://www.inventronics-co.com/technical-support/>.